

A

B

C

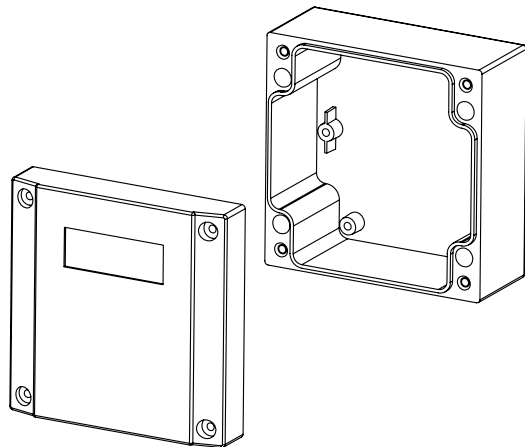

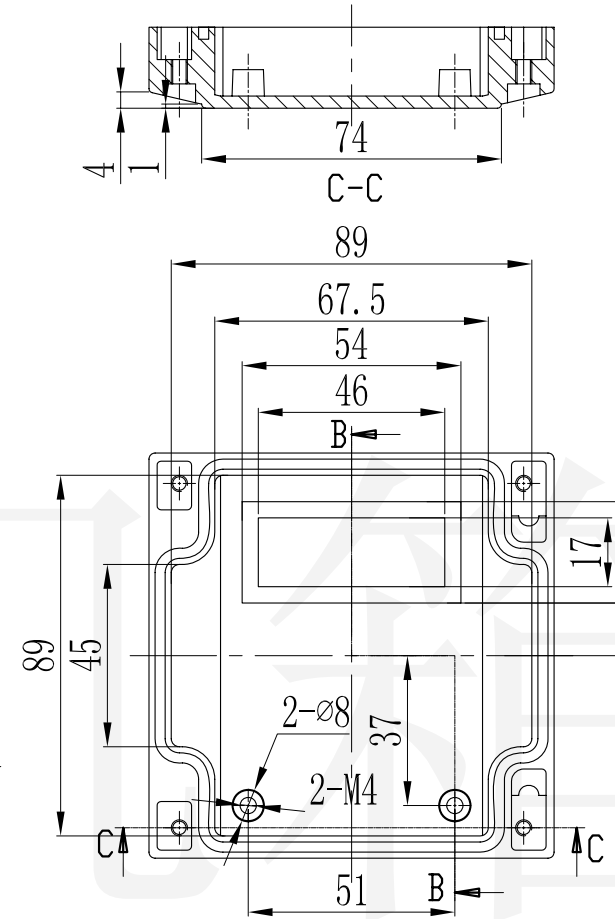
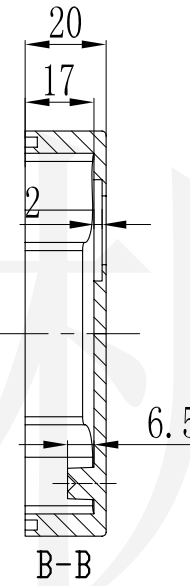
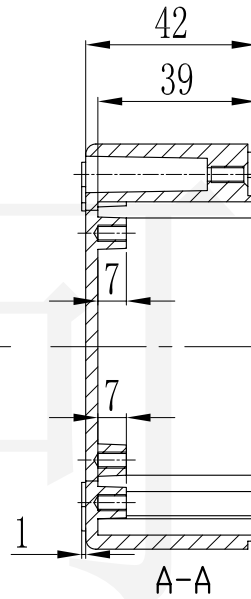
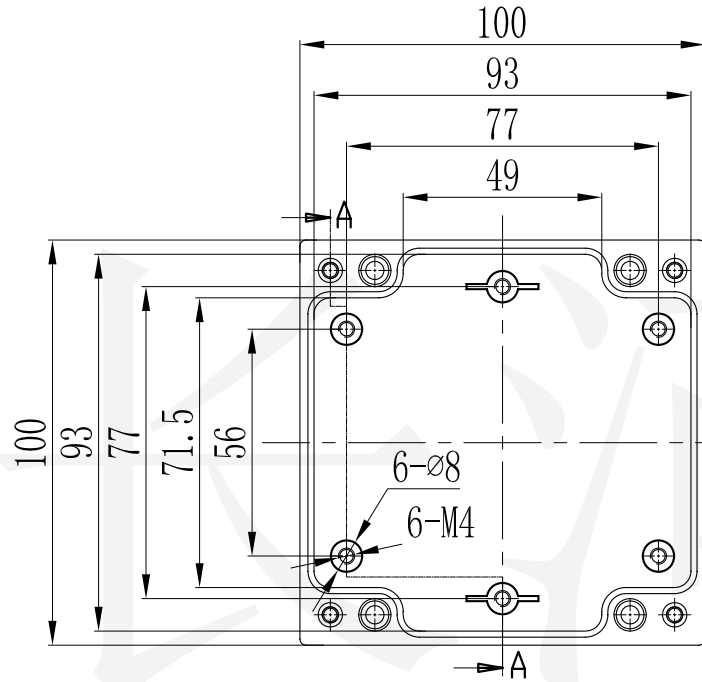

底图总号

D

旧底图总号

日期

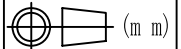
签字

制图 Drawing	审核 Auditing	批准 Confirm	产品名称 Product Name	铝合金防水盒 Sealed aluminium enclosure	材料 Material	Die-Cast aluminium
			产品编号 Product Code	11A-27-1	视图 Project View	 (m m)
					图纸比例 Drawing Scale	
共 张 第 张			 宁波大洋壳体有限公司 Ningbo Dayang Enclosures CO.,LTD			

A

B

C

D