

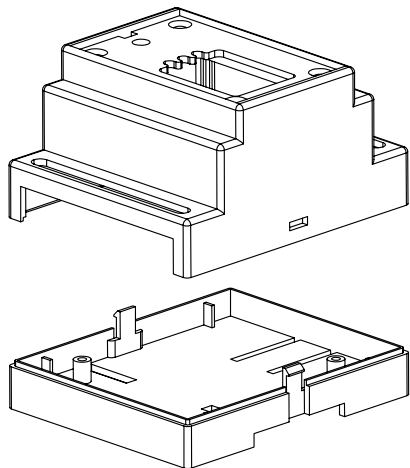

长河机箱
Changhe Enclosures

<http://www.enclosures.com.cn>

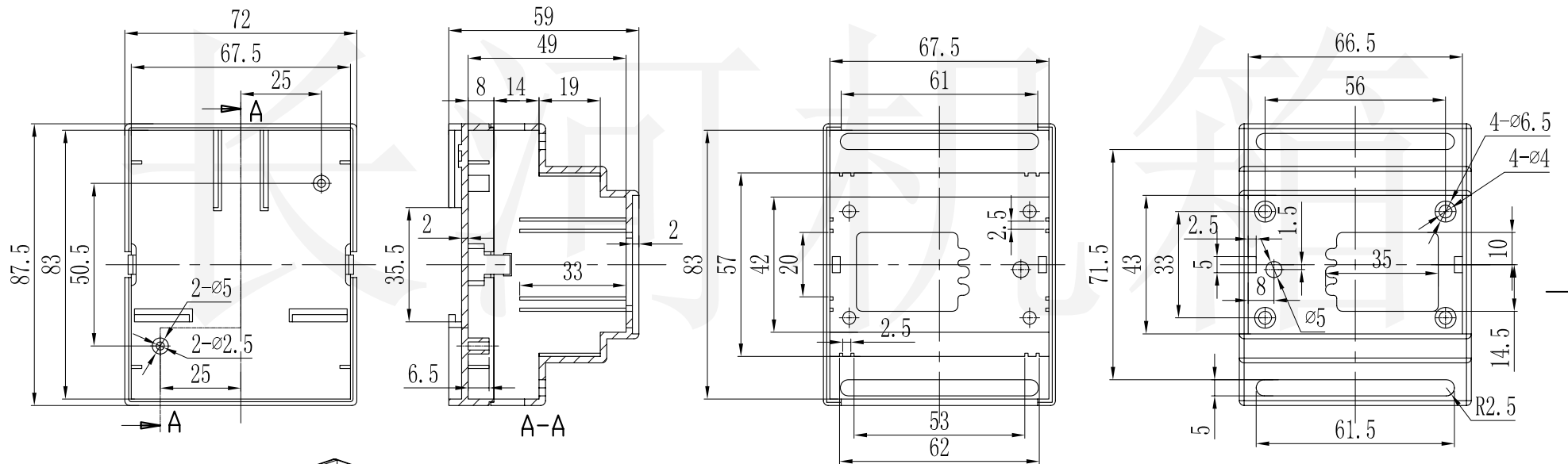
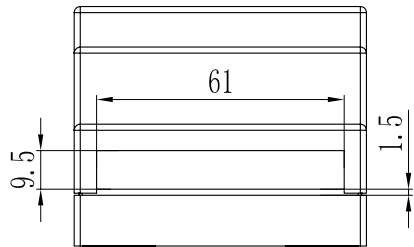

底图总号	
D	
旧底图总号	
日期	签字

制图 Drawing	审核 Auditing	批准 Confirm	产品名称 Product Name	工控机壳 DIN rail PLC enclosure	材料 Material	ABS
			产品编号 Product Code	14-48-1	视图 Project View	(m m)
			共 张 第 张		图纸比例 Drawing Scale	
			宁波大洋壳体有限公司 Ningbo Dayang Enclosures CO., LTD			