

A

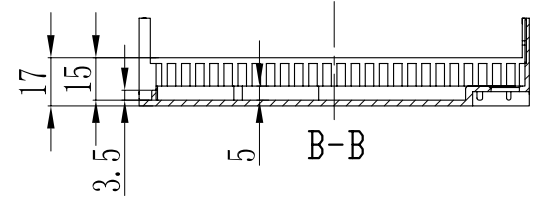

B

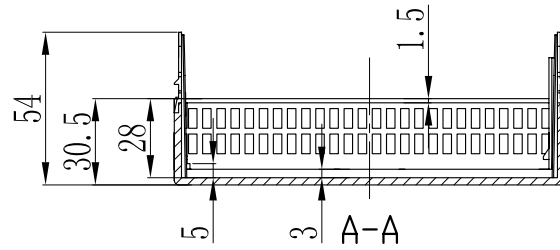
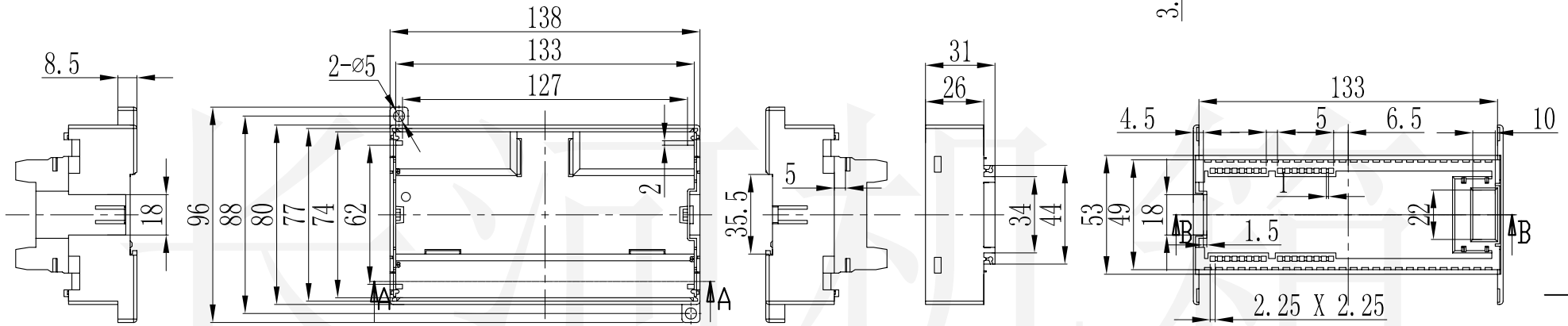

C

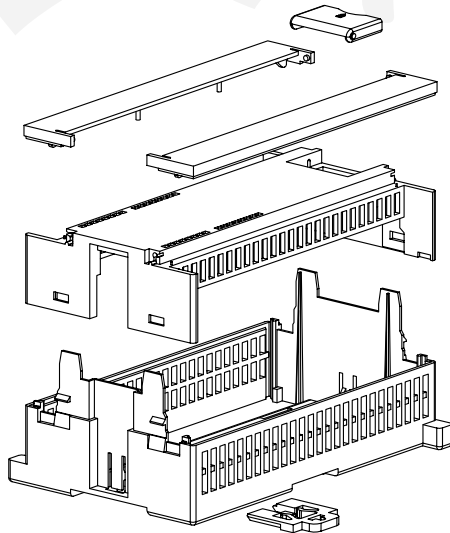



底图总号

D

旧底图总号

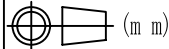
日期 签字

制图 Drawing	审核 Auditing	批准 Confirm	产品名称 Product Name	工控机壳 DIN rail PLC enclosure	材料 Material	ABS
			产品编号 Product Code	14-64	视图 Project View	 (m m)
					图纸比例 Drawing Scale	
共 张 第 张			 宁波大洋壳体有限公司 Ningbo Dayang Enclosures CO.,LTD			

A

B

C

D