

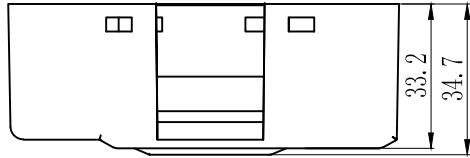

长河机箱  
Changhe Enclosures

<http://www.enclosures.com.cn>

A



B

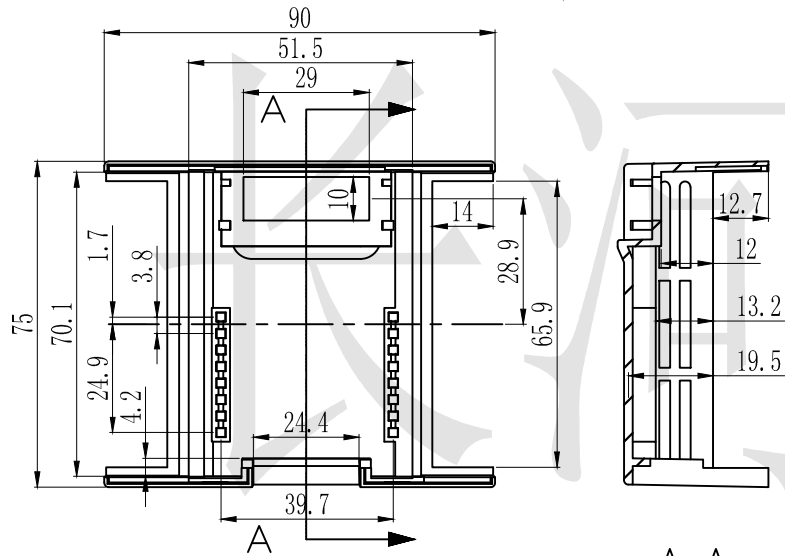

A-A

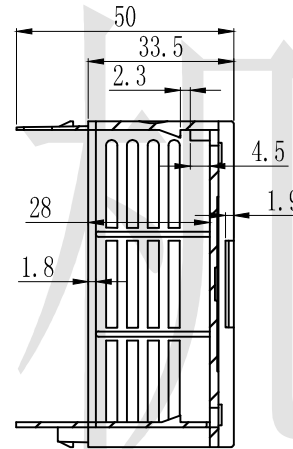

B-B

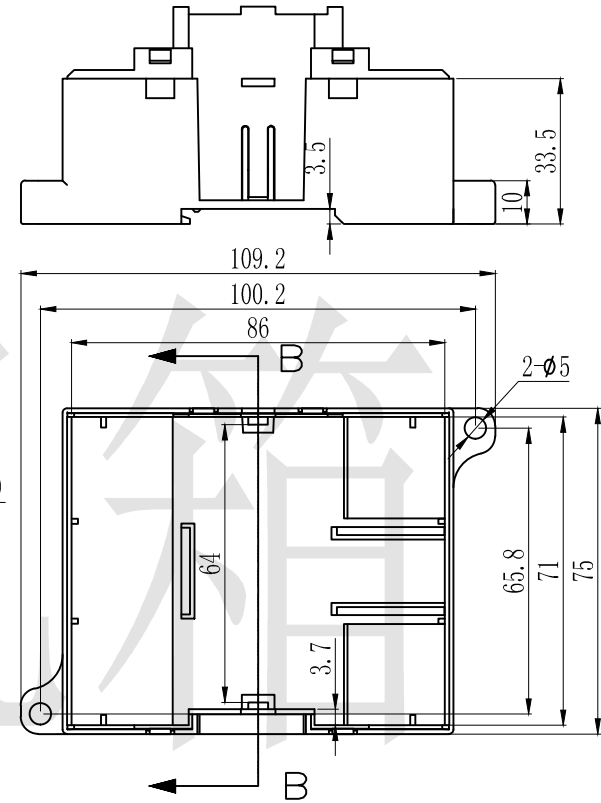

C

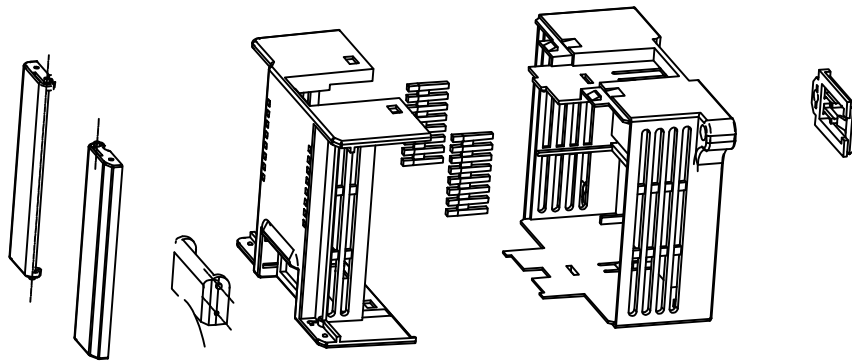

底图总号

D

旧底图总号

日期签字

注：图纸尺寸仅供参考，请以实物为准。

制图 Drawing	审核 Auditing	批准 Confirm	产品名称 Product Name	工控机壳 DIN rail PLC enclosure	材料 Material	ABS
			产品编号 Product Code	14-84	视图 Project View	(m m)
					图纸比例 Drawing Scale	
共 张 第 张				宁波大洋壳体有限公司 Ningbo Dayang Enclosures CO.,LTD		