

A

139.2

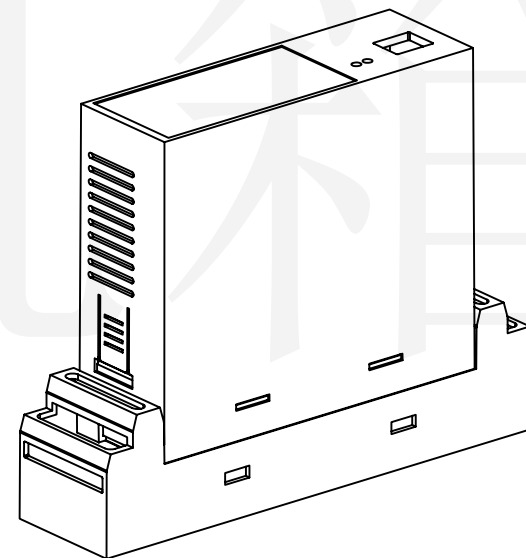

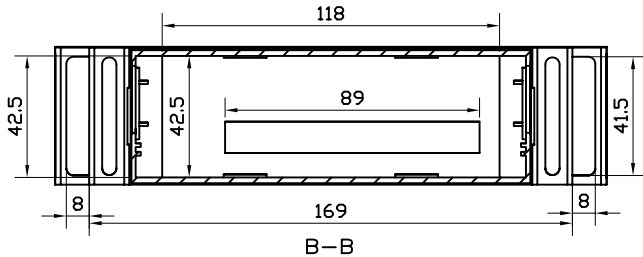
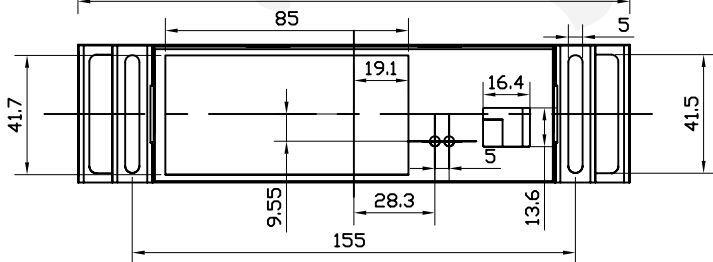
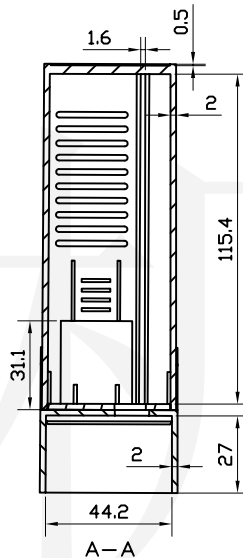
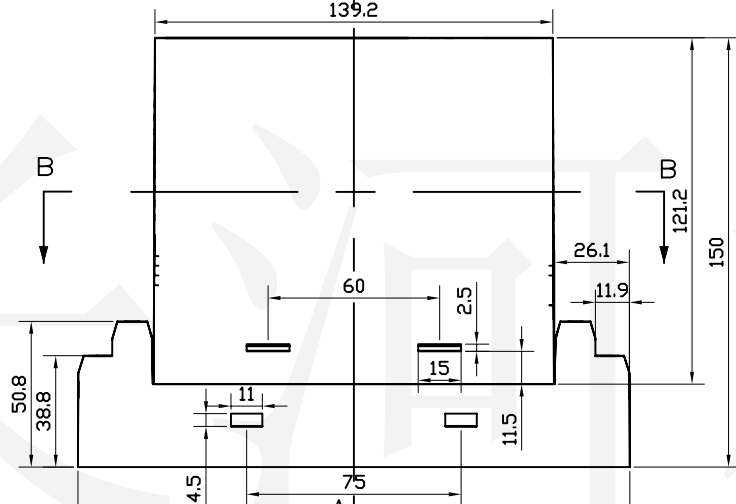
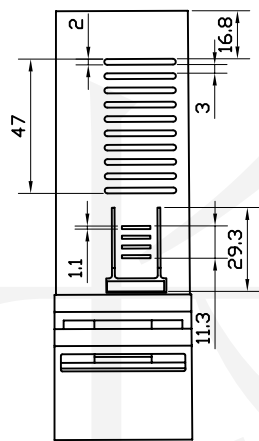

底图总号

D

旧底图总号

日期 签字

制图 Drawing	审核 Auditing	批准 Confirm	产品名称 Product Name	卡式模组合 DIN rail terminal enclosure	材料 Material	ABS
			产品编号 Product Code	15-20	视图 Project View	 (m m)
					图纸比例 Drawing Scale	1:3
共 张 第 张				 宁波大洋壳体有限公司 Ningbo Dayang Enclosures CO.,LTD		