

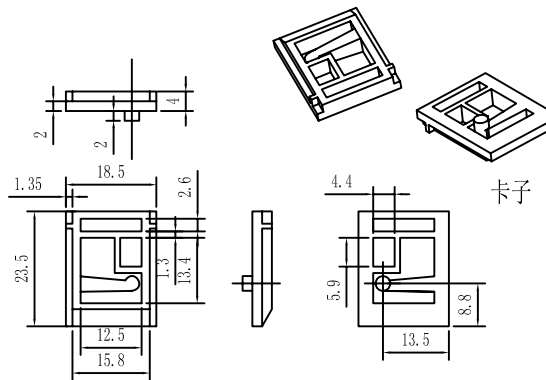

长河机箱
Changhe Enclosures

<http://www.enclosures.com.cn>



卡子

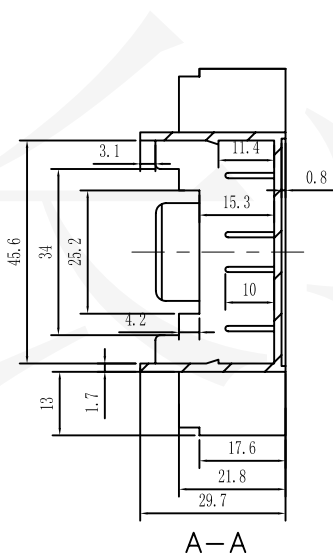

A-A

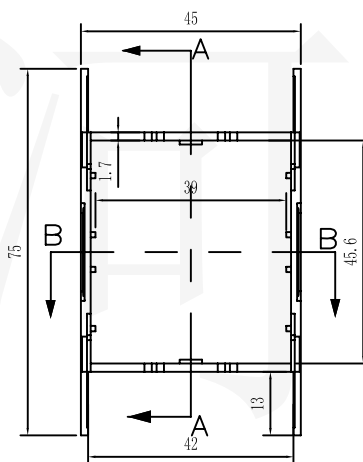

B-B

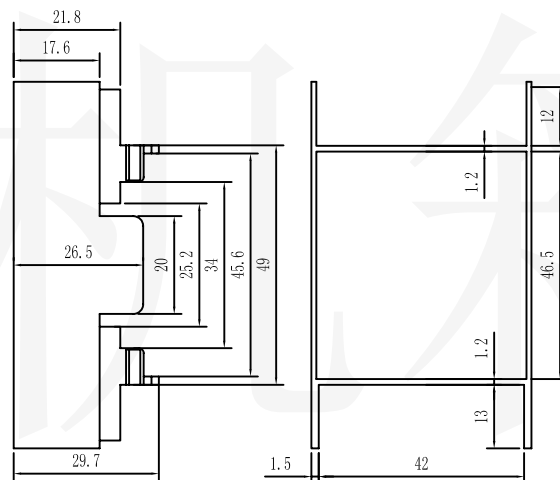
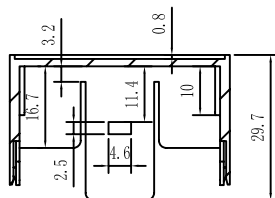

注：图纸尺寸仅作参考，具体尺寸误差以实物为准。

制图 Drawing	审核 Auditing	批准 Confirm	产品名称 Product Name	卡式模组合 DIN rail terminal enclosure	材料 Material	
			产品编号 Product Code	15-6-1上盖	视图 Project View	(mm)
					图纸比例 Drawing Scale	
共 张 第 张			宁波大洋壳体有限公司 Ningbo Dayang Enclosures CO., LTD			

底图总号	
D	
旧底图总号	
日期	签字



长河机箱
Changhe Enclosures

<http://www.enclosures.com.cn>

A

B

C

D

底图总号

旧底图总号

日期 签字

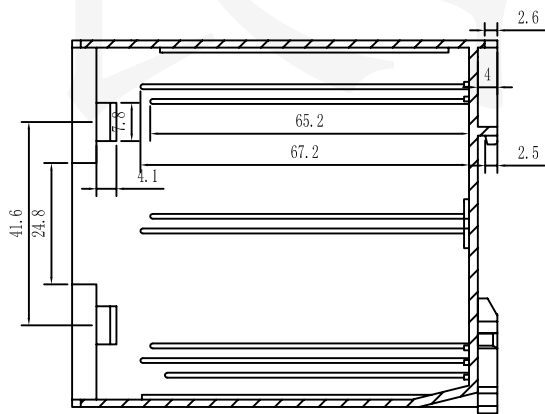

A-A

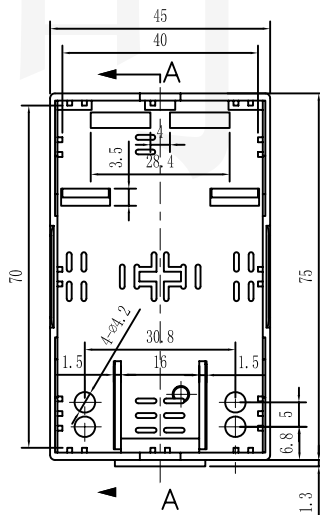

A

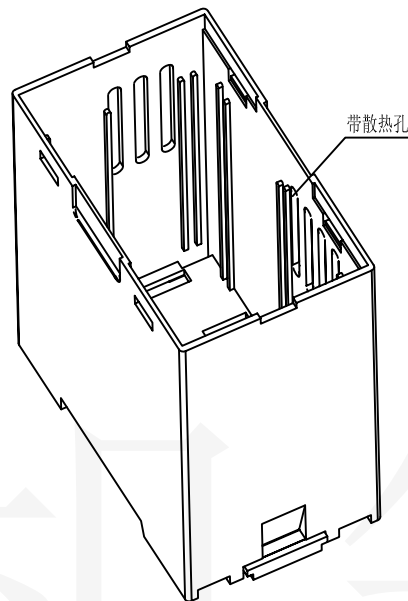
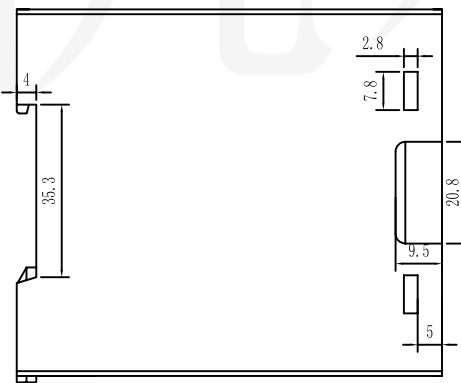
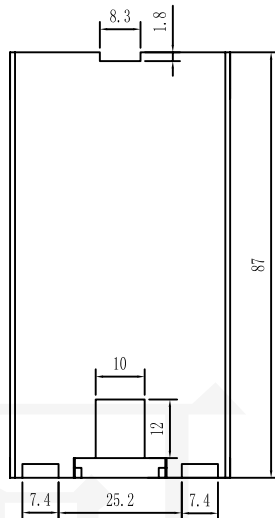

注：图纸尺寸仅作参考，具体尺寸误差以实物为准。

制图 Drawing	审核 Auditing	批准 Confirm	产品名称 Product Name	卡式模组合 DIN rail terminal enclosure	材料 Material	
			产品编号 Product Code	15-6-1下壳	视图 Project View	(mm)
					图纸比例 Drawing Scale	
共 张 第 张			宁波大洋壳体有限公司 Ningbo Dayang Enclosures CO.,LTD			