



长河机箱
Changhe Enclosures

<http://www.enclosures.com.cn>

A

B

C

D

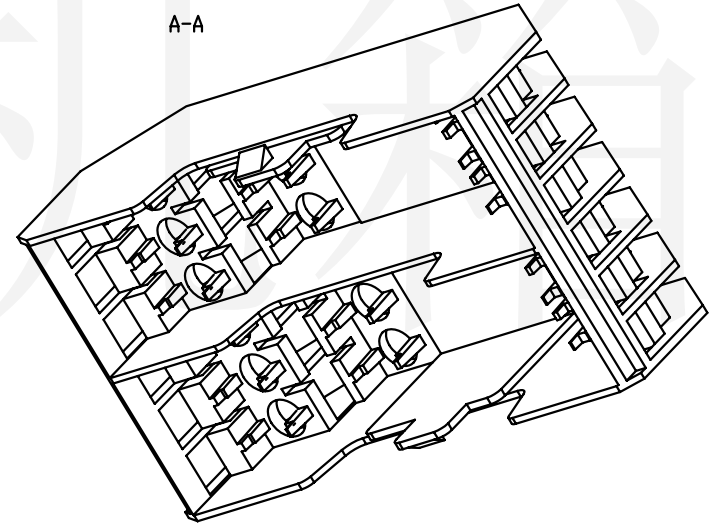
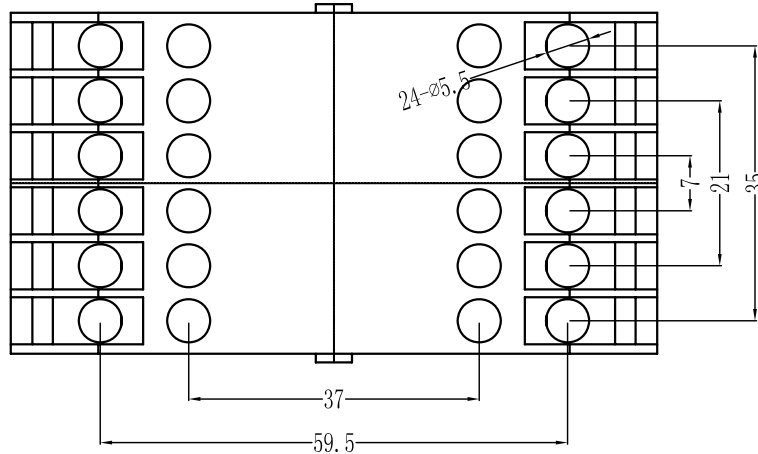
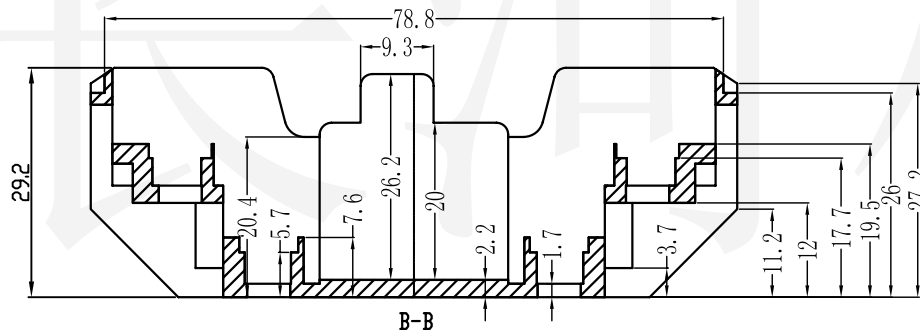
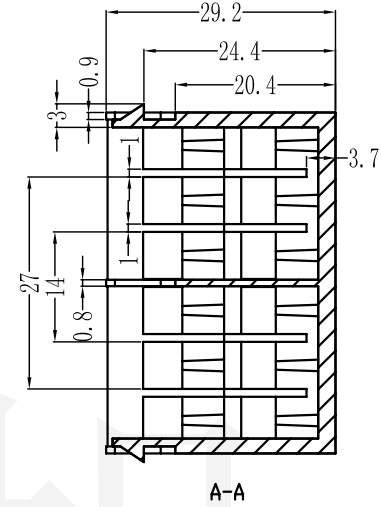
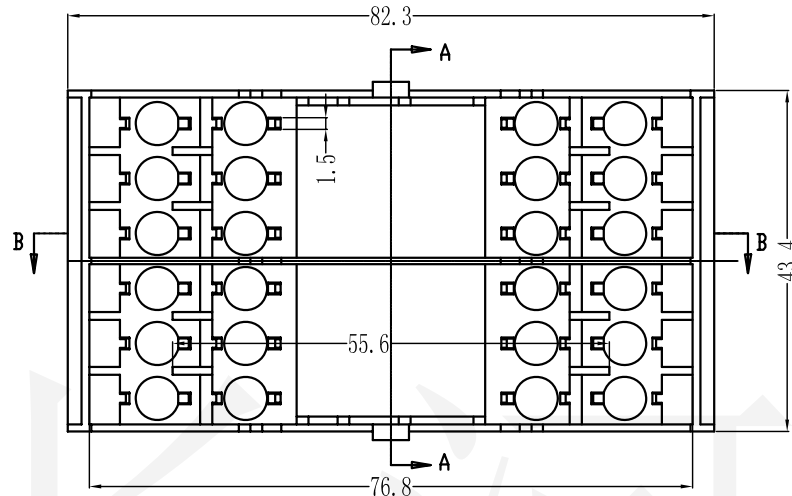

底图总号	
D	
旧底图总号	
日期	签字

制图 Drawing	审核 Auditing	批准 Confirm	产品名称 Product Name	卡式模组合 DIN rail terminal enclosure	材料 Material	ABS
			产品编号 Product Code	15-7上壳	视图 Project View	(m m)
					图纸比例 Drawing Scale	
共 张 第 张			宁波大洋壳体有限公司 Ningbo Dayang Enclosures CO.,LTD			

A

B

C

D



长河机箱
Changhe Enclosures

<http://www.enclosures.com.cn>

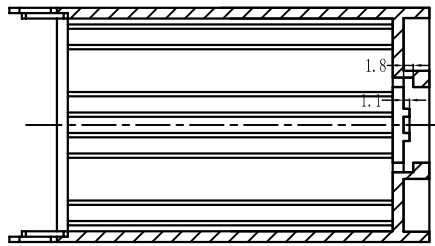

D-D

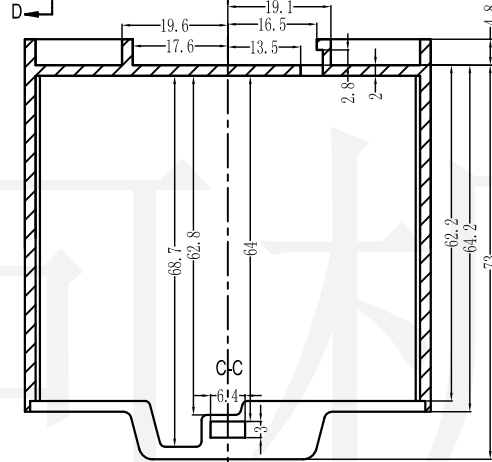
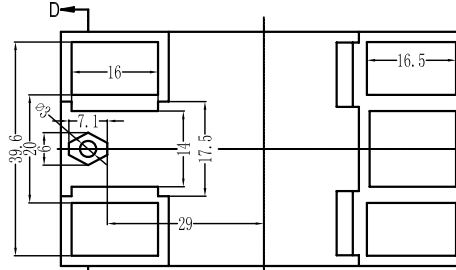

A-A

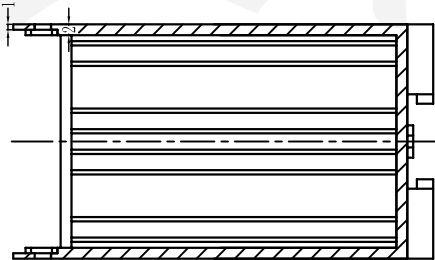

A-A

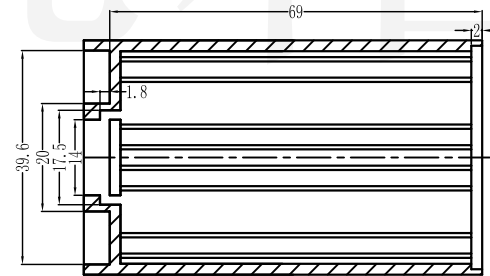
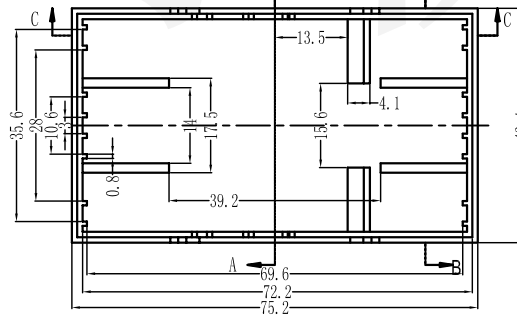



B-B

底图总号	
D	
旧底图总号	
日期	签字

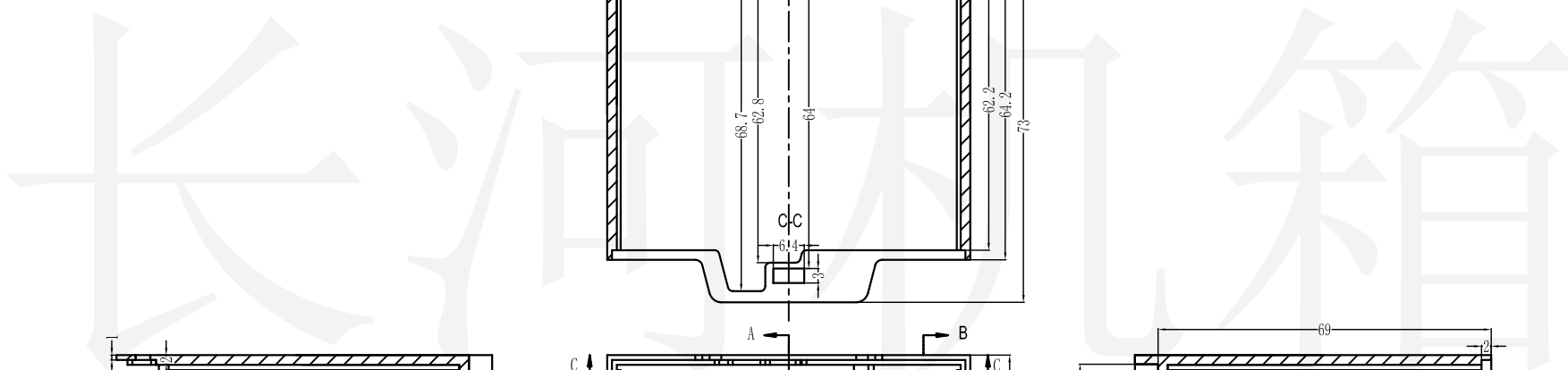
制图 Drawing	审核 Auditing	批准 Confirm	产品名称 Product Name	卡式模组合 DIN rail terminal enclosure	材料 Material	ABS
			产品编号 Product Code	15-7下壳	视图 Project View	(m m)
共 张 第 张					图纸比例 Drawing Scale	
					宁波大洋壳体有限公司 Ningbo Dayang Enclosures CO., LTD	

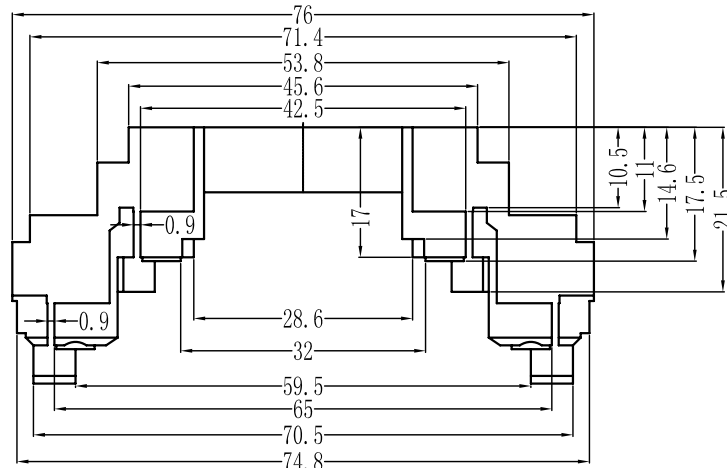
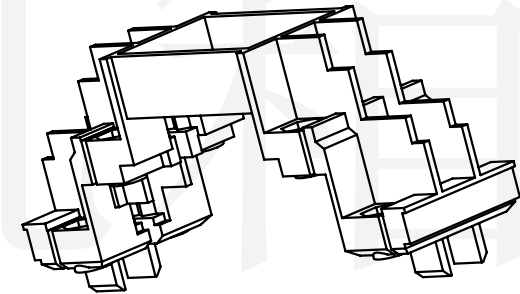
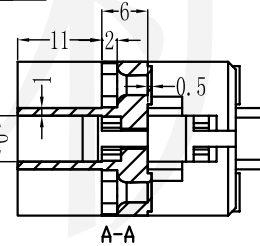
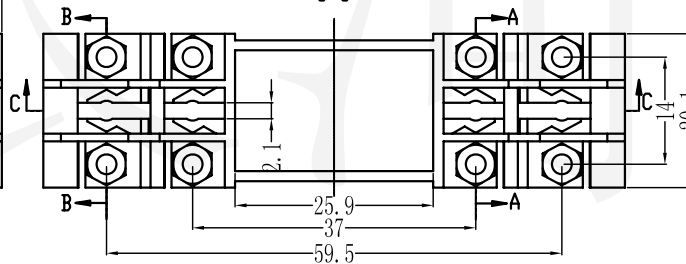
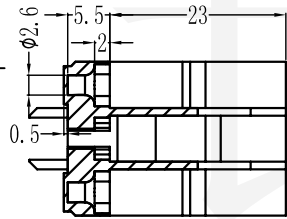
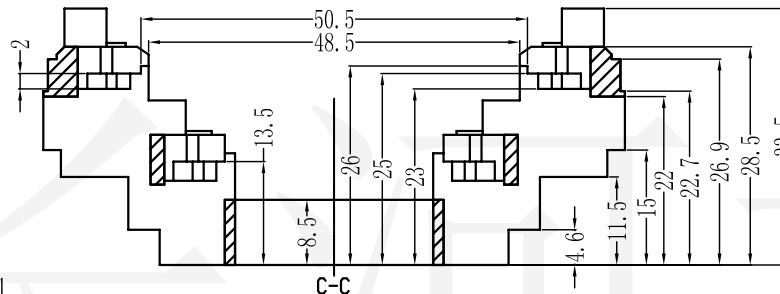
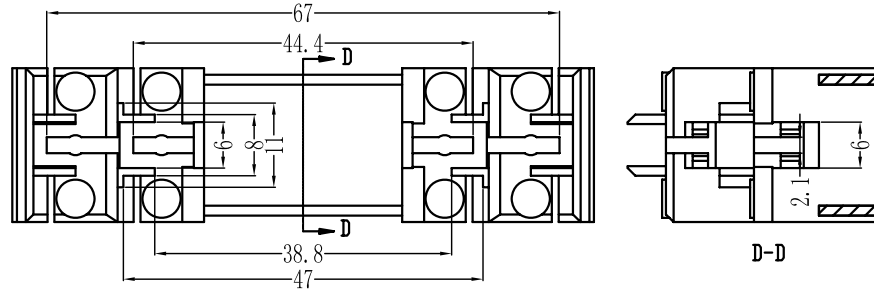



制图 Drawing	审核 Auditing	批准 Confirm	产品名称 Product Name	卡式模组合 DIN rail terminal enclosure	材料 Material	ABS
			产品编号 Product Code	15-7中间件	视图 Project View	 (m m)
					图纸比例 Drawing Scale	
共 张 第 张			 宁波大洋壳体有限公司 Ningbo Dayang Enclosures CO.,LTD			

底图总号	
D	
旧底图总号	
日期	签字



长河机箱
Changhe Enclosures

<http://www.enclosures.com.cn>

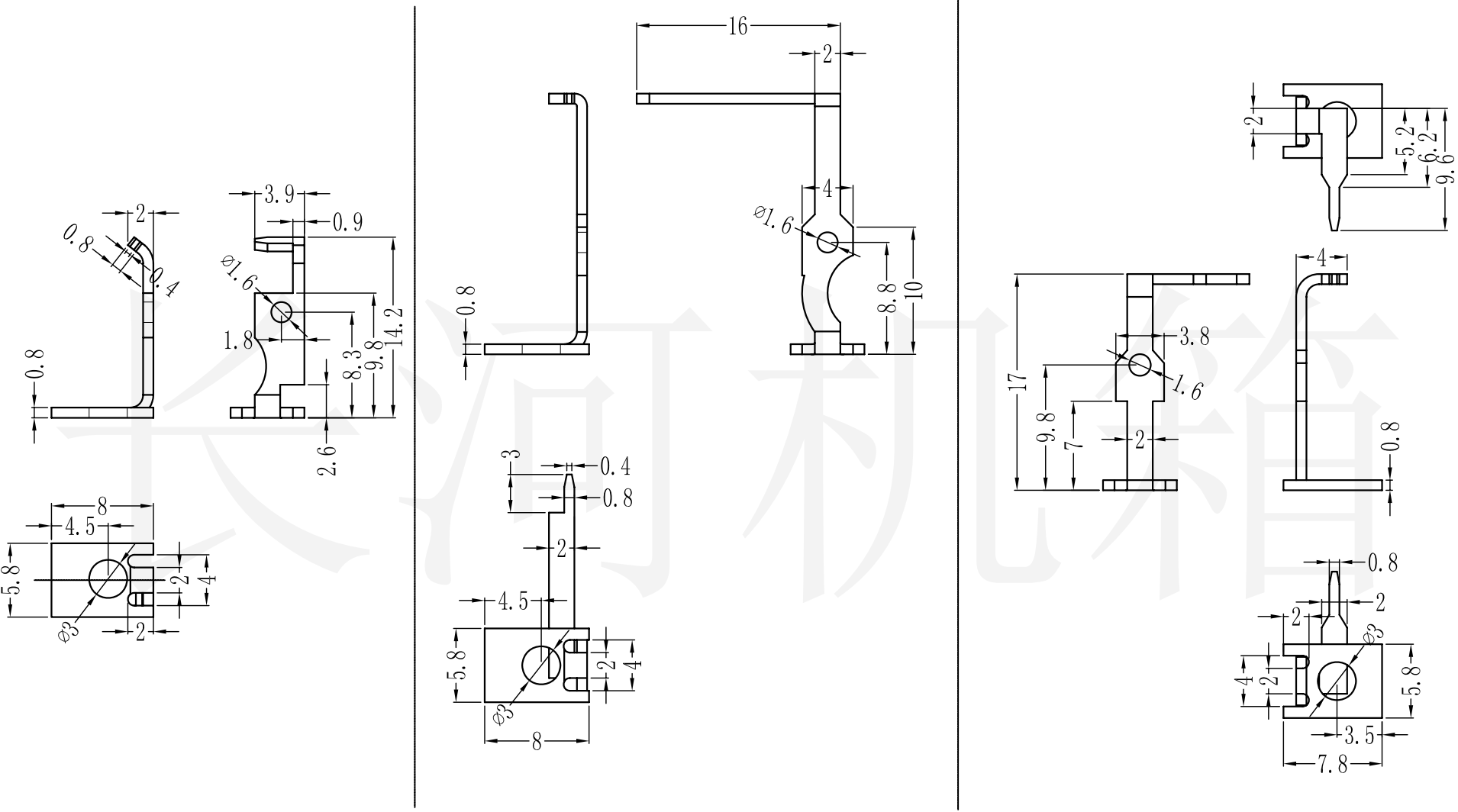

底图总号	
D	
旧底图总号	
日期	签字

制图 Drawing	审核 Auditing	批准 Confirm	产品名称 Product Name	卡式模组合 DIN rail terminal enclosure	材料 Material	ABS
			产品编号 Product Code	15-7插件	视图 Project View	(m m)
					图纸比例 Drawing Scale	
共 张 第 张			宁波大洋壳体有限公司 Ningbo Dayang Enclosures CO.,LTD			