

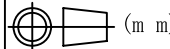



底图总号	
D	
旧底图总号	
日期	签字

制图 Drawing	审核 Auditing	批准 Confirm	产品名称 Product Name	卡式模组合 DIN rail terminal enclosure	材料 Material	ABS
			产品编号 Product Code	15-8上壳	视图 Project View	 (m m)
					图纸比例 Drawing Scale	1:3
共 张 第 张				 宁波大洋壳体有限公司 Ningbo Dayang Enclosures CO.,LTD		

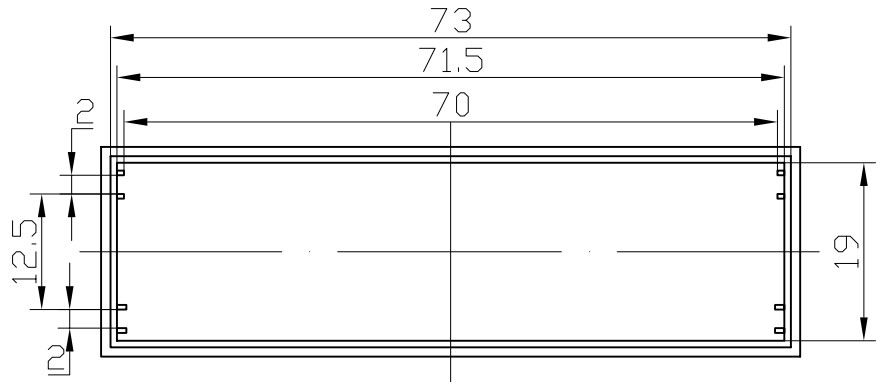
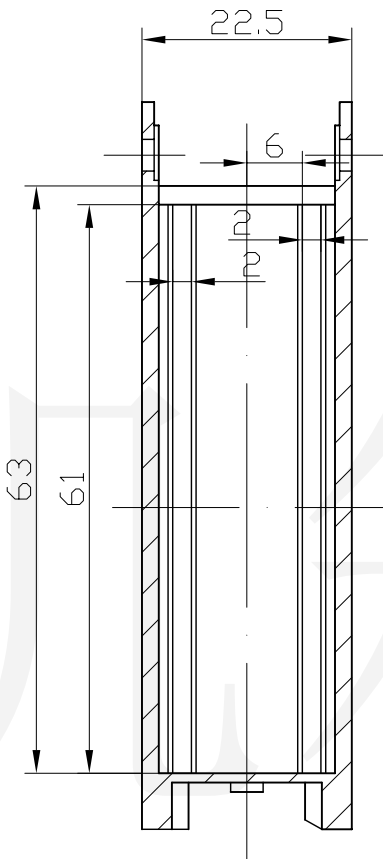
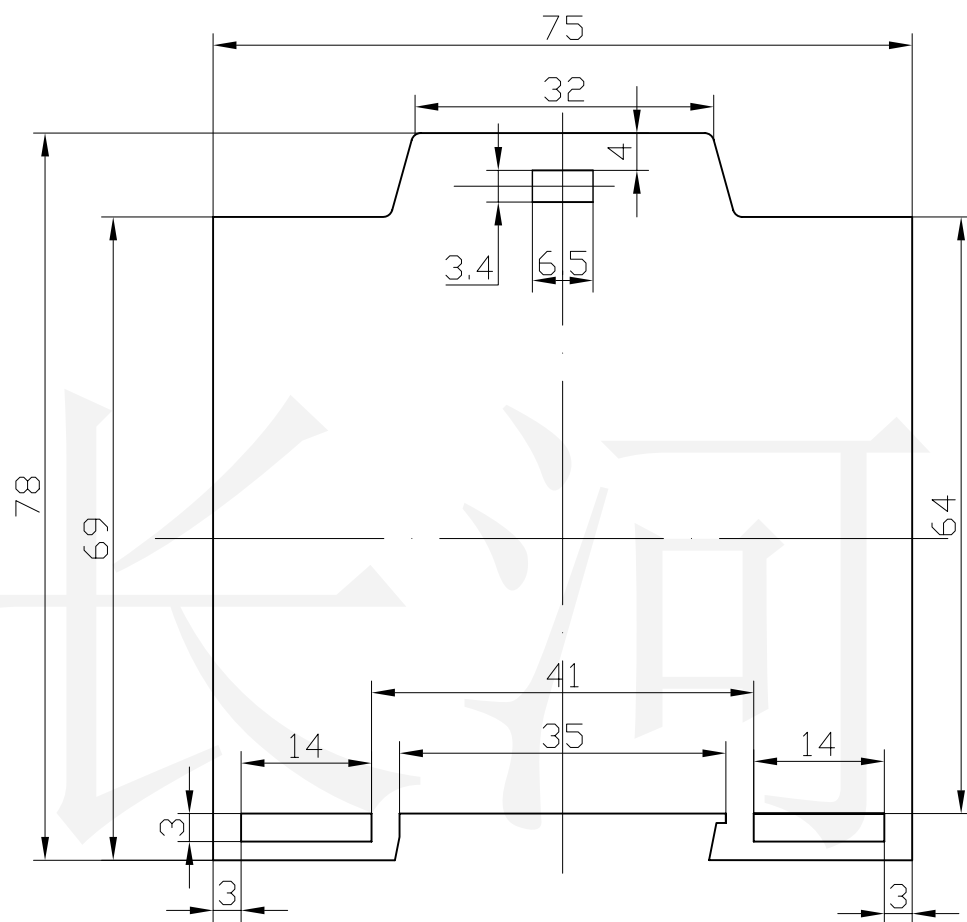
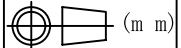

底图总号	
D	
旧底图总号	
日期	签字

制图 Drawing	审核 Auditing	批准 Confirm	产品名称 Product Name	卡式模组合 DIN rail terminal enclosure	材料 Material	ABS
			产品编号 Product Code	15-8下壳	视图 Project View	 (m m)
					图纸比例 Drawing Scale	1:3
共 张 第 张				 宁波大洋壳体有限公司 Ningbo Dayang Enclosures CO.,LTD		