

A

B

C

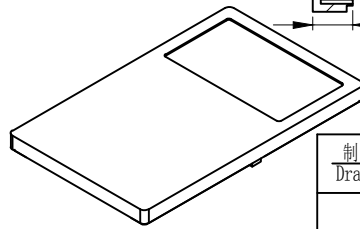

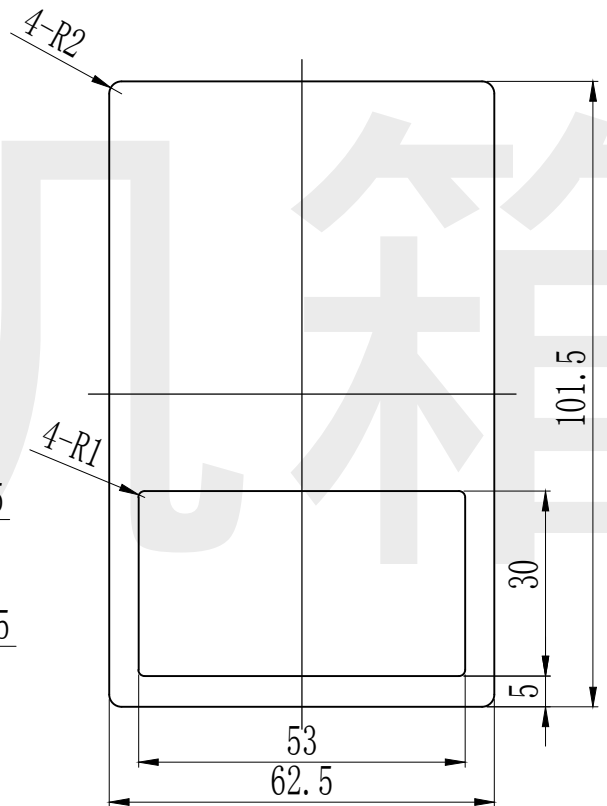
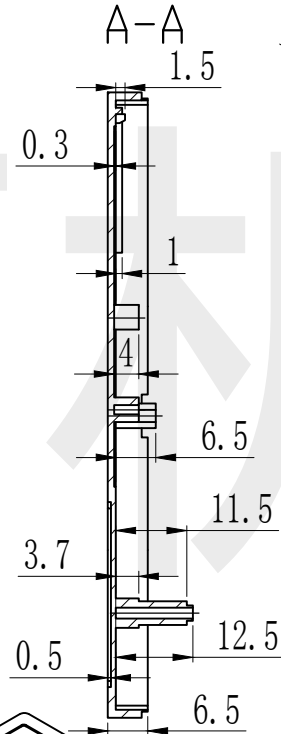
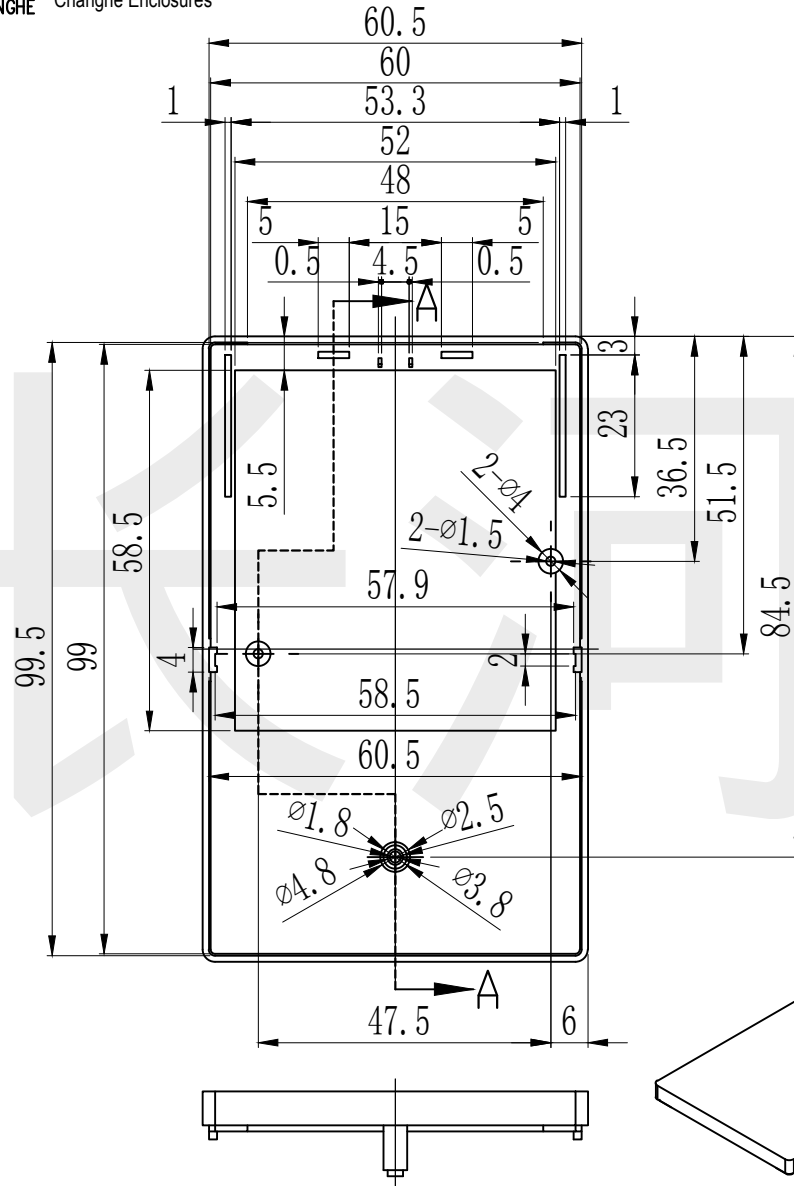

底图总号

D

旧底图总号

日期 签字

注：图纸尺寸仅供参考，请以实物为准。

制图 Drawing	审核 Auditing	批准 Confirm	产品名称 Product Name	便携式仪表壳 Hand held enclosure	材料 Material	ABS
			产品编号 Product Code	17-64上壳	视图 Project View	 (m m)
					图纸比例 Drawing Scale	
共 张 第 张			 宁波大洋壳体有限公司 Ningbo Dayang Enclosures CO.,LTD			

A

B

C

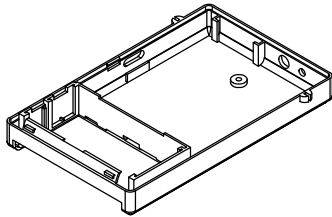
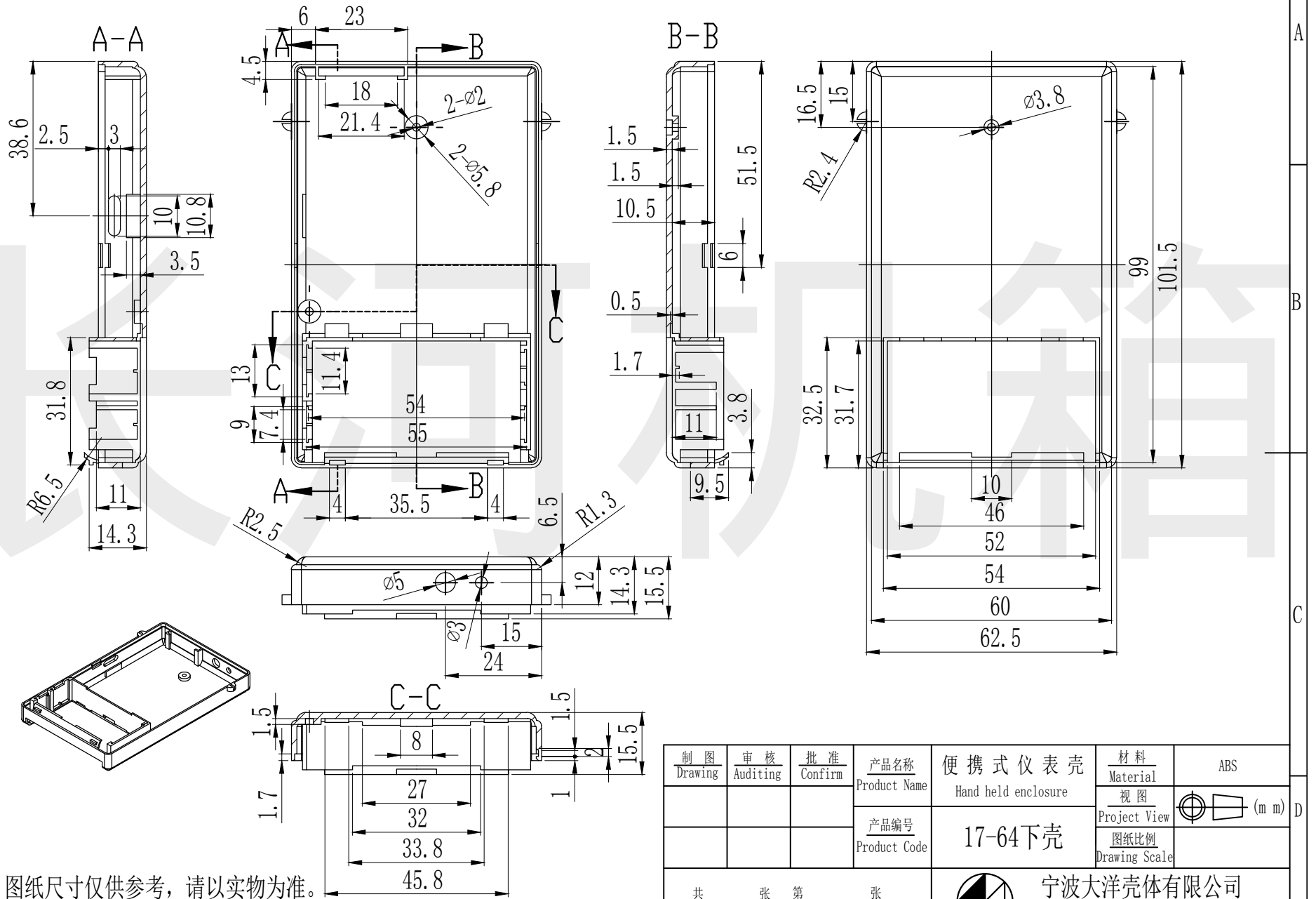

底图总号	
D	
旧底图总号	
日期	签字

注：图纸尺寸仅供参考，请以实物为准。

制图 Drawing	审核 Auditing	批准 Confirm	产品名称 Product Name	便携式仪表壳 Hand held enclosure	材料 Material	ABS
			产品编号 Product Code	17-64下壳	视图 Project View	 (m m)
共 张 第 张				 宁波大洋壳体有限公司 Ningbo Dayang Enclosures CO.,LTD		

A

B

C

D